



**BIDDULPH
REFRIGERATION**
COMMERCIAL & INDUSTRIAL REFRIGERATION



Ziegra 350kg Flake Ice Machine

Z B E 3 5 0

Information Sheet
2025

Biddulph Refrigeration

A large industrial ice machine, likely a Ziegra model, is shown in a snowy mountain setting. The machine is a tall, stainless steel cabinet with two dispensing nozzles at the top. In the background, there are snow-capped mountains and a smaller piece of equipment. The foreground is a dark grey diagonal shape that transitions into a bright orange diagonal shape at the bottom right.

Outline

- 01** Ziegra Ice Machines
- 02** Ziegra Ice
- 03** Main Features
- 04** Dimensions
- 05** Connections
- 06** Technical Specifications
- 07** Included with Ice Machine
- 08** Options
- 09** Contact us



Ziegra Ice Machines

Ziegra Ice machines are designed and manufactured in Germany according to CE standards.

Ziegra ice machines have a reputation for robust build and long life. The Ice machine is a single, complete packaged unit, comprising integrated refrigeration, controls and ice-making.

Ziegra ice machines use a closed water system and static evaporators ensuring better hygiene standards and increased reliability.

Why Ziegra Ice?

Ziegra Flake Ice is world renowned and ideal for any process requiring fast yet gentle ice cooling. We stock a range of standard and custom Ziegra ice systems ensuring we have the solution for you.





Ziegra Ice

Ziegra flake ice offers the perfect solution for processes demanding fast yet gentle cooling. Its unique temperature delivers maximum cooling power while minimizing energy use, making it both environmentally friendly and cost-effective.

An ice temperature of -0.5°C allows for ideal cooling:

- Fast cooling with long lasting cooling effect
- No damage to product from freeze burn
- Ice does not stick together
- Suitable for all day storage
- High cooling effect with low energy input requirement

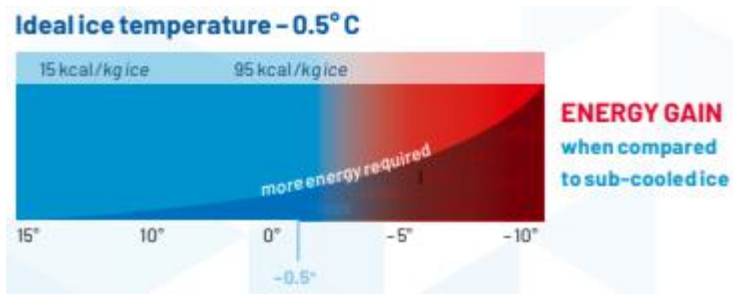



Ziegra Flake Ice

Flake ice has an optimal cooling temperature of -0.5°C meaning:

- Lower energy requirements when compared to sub-cooled ice
 - Ice doesn't stick together or form large lumps
 - Product does not freeze or become damaged
 - Suitable for either fast or long term cooling



Pieces of ice up to 9.5mm thick. Macro ice is durable, can be stored for long periods of time and provides excellent long-term cooling, e.g. for fish transport and goods displays.

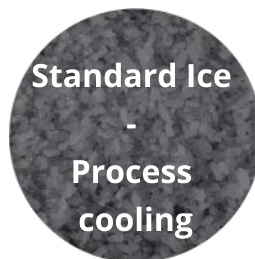

A mix of small and large ice pieces guaranteeing a high cooling capacity and good durability - ideal for cutting and process cooling.



Small pieces of ice, average size of 5mm. The ice pieces quickly incorporate into any mix and dissolve efficiently cooling the mix. Suitable for mixing processes and sensitive goods such as fish filets.

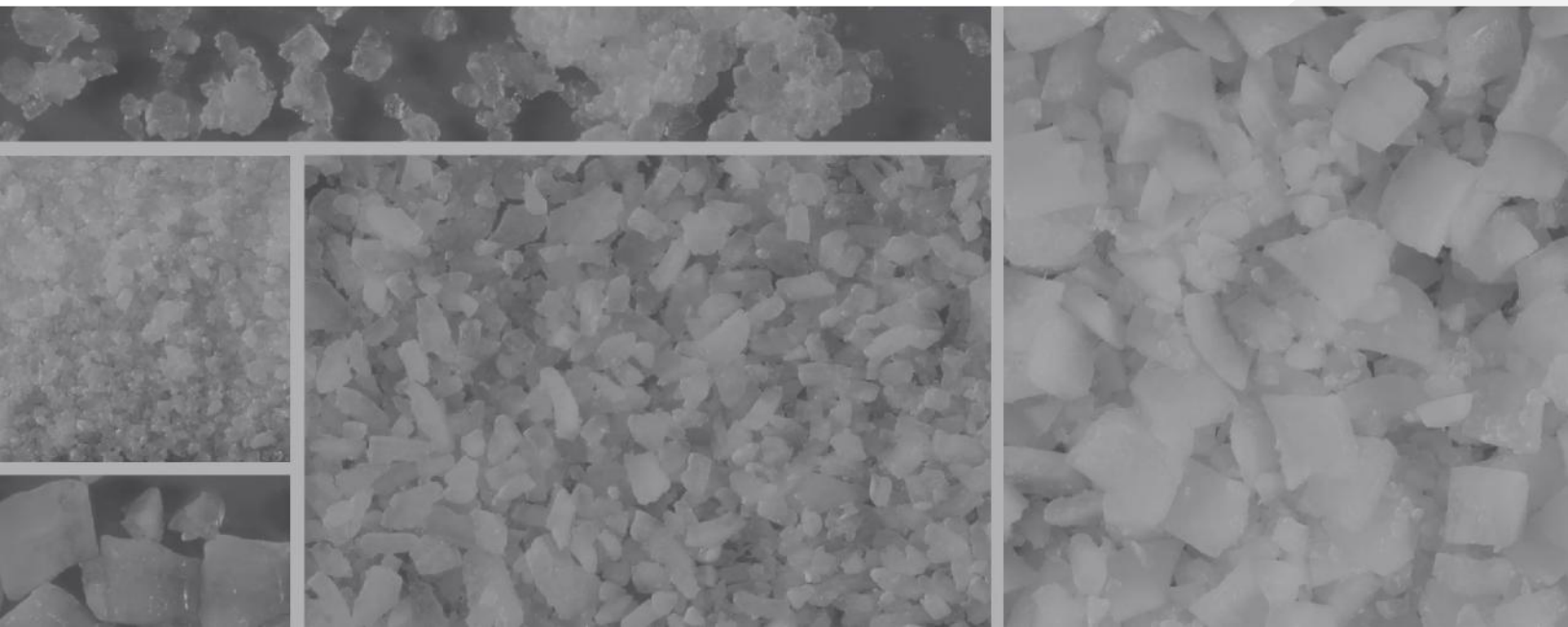



Main Features

ZBE 350

The Ziegra UBE 350 ice machine makes up to 350kg per 24 hours of flake ice in one of two sizes.

There are three models to choose from;

- **ZBE 350 CoolNat** with a natural refrigerant for standard applications.
- **ZBE 350** with R452a refrigerant for applications and environments where more flexibility is required.
- **ZBE 350W** with a water cooled condenser (mainly used for sauna applications)

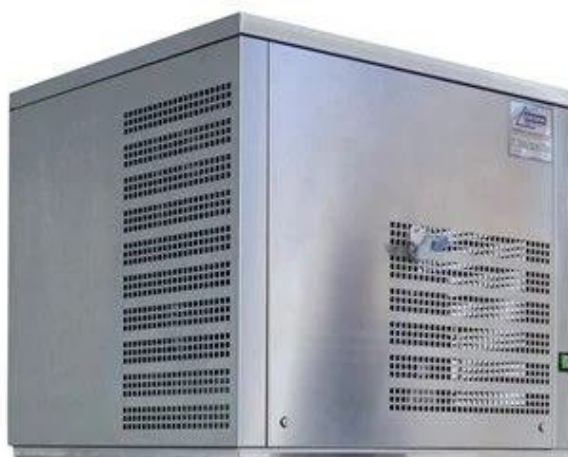

- Ice level control system included as standard
- Granular flake ice made at optimum temperature of -0.5°C .
- Two sizes of ice flake available: micro and standard
- Hygienic design with a sealed water system
- External water filtration system supplied as standard.
- Designed for continuous operation 24/7
- Stainless steel construction
- No moving parts in refrigeration circuit lowering risk of gas leaks





Dimensions

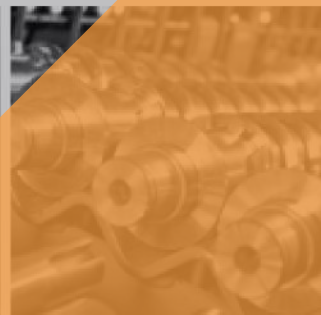
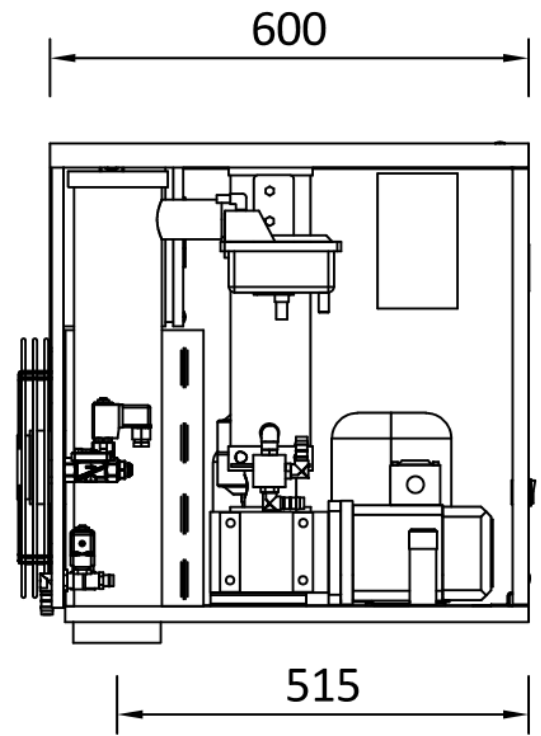
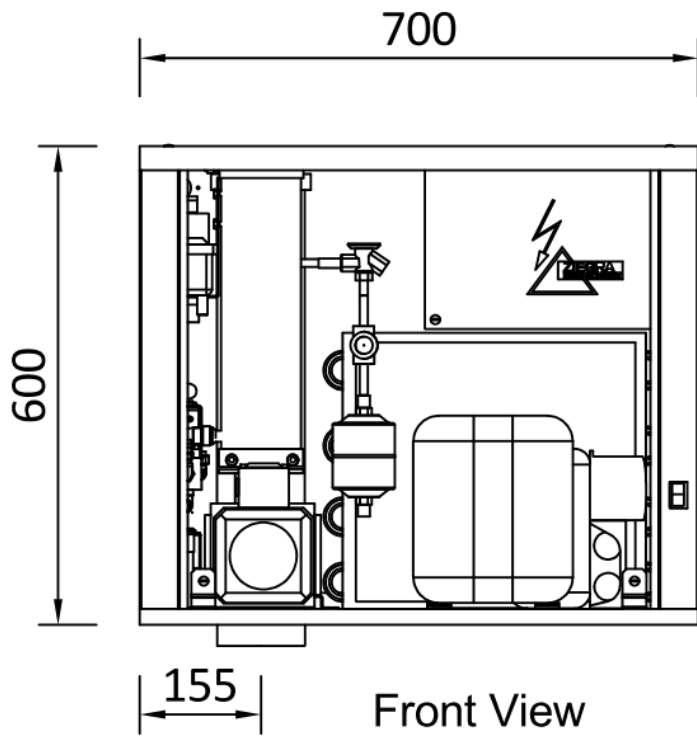



Connections

Connection Specifications

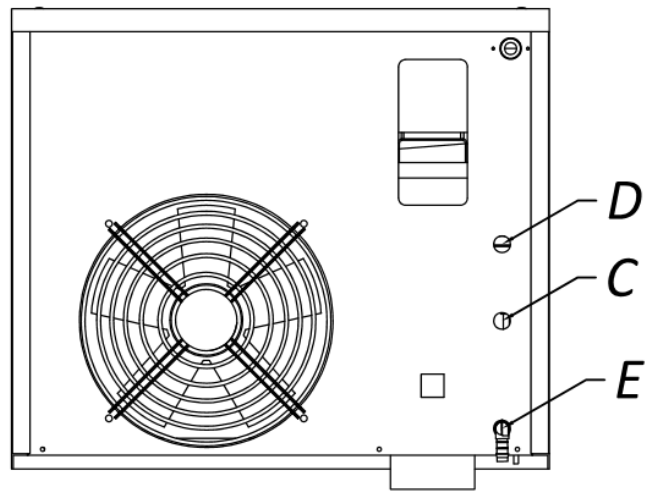

Air-cooled rear view

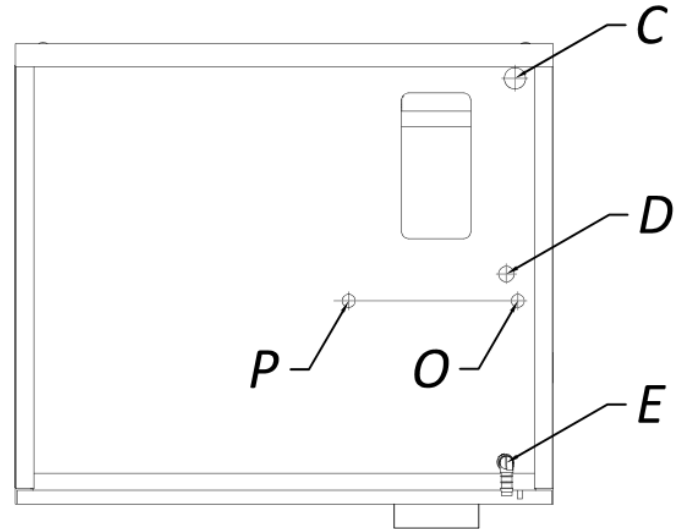

Water-cooled rear view

ZBE 350 CoolNat and ZBE 350

- C: Water supply 3/4" BSP
- D: Electrical connection 230V / 1 / 50Hz UK plug
- E: Water drain 14mm

ZBE 350W - optional water cooled

- C: Water supply
- D: Electrical connection 230V / 1 / 50Hz UK plug
- E: Water drain 14mm
- O: Cooling water inlet G 1/2"
- P: Cooling water outlet G 1/2"





Technical Specifications	ZBE 350 Standard	ZBE 350 Water Cooled	ZBE 350 CoolNat
350kg/24hr Nominal Capacity*	20°C air and 15°C water	15°C water	20°C air and 15°C water
Dimensions	700 x 600 x 610mm		
Weight	90kg		
Cabinet	Stainless Steel 1.4301		
Electricity Power Consumption Current Consumption	1.6kW 7.3A		1.6kW 7.0A
Provided by Customers Electric Supply fuse, slow blow cable cross section, Cu	1/NPE ~ 230V 50Hz 13A 1.5mm ²		
Water Supply/Drain Provided by customer Pressure Quality pH-value Hardness Temperature	¾" BSP male / 14mm hose nozzle 2-5 bar drinking water 7.2 – 9.5 pH 6 – 14 °dH/ 100 – 250 mg CaCO ₃ /l 5°C - 30°C		
Cooling water inlet/outlet		½" BSP Male	
Ambient Temperature	5°C to 42°C		
Condenser Airflow Heat Emission	air cooled 1400 m ³ /h 2.6 kW	water cooled 160 litres/h 2.6 kW	air cooled 880 m ³ /h 2.6 kW
Refrigerant Refrigerant Charge ODP GWP CO₂ tonnes equivalent F-Gas leak check	R452A 1.0kg 0 2140 2.14 Annual		R290 0.114kg 0 3 0.000336 Annual
Compressor Refrigeration Capacity Evaporation Temperature Condensation Temperature	Fully hermetic 1.62kW -17°C 33°C		Fully hermetic 1.5kW -17°C 34°C
Noise Level	55dBA (3m)		
Shipping dimensions	0.76 x 0.66 x 0.79m		
Shipping Weight	95kg		

*according to site conditions. Air temperature, water temperature, water chemistry, air contamination and installation parameters can all effect ice output.

All product, product specifications and data are subject to change without notice

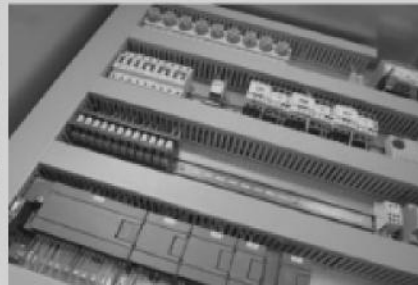
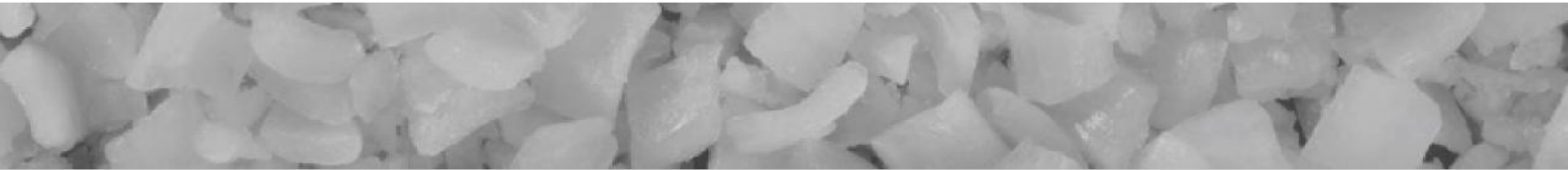

Included with Ice Machine

The UBE 350 ice machine will be delivered according to CE standards and is ready for connection to water, power and a drain.

Includes:

- High pressure pressostat
- Water supply control
- Motor protection for the compressor
- 1 x Flexible ice discharge hose
- Ice level control by thermostat
- 1 x connecting cable 3.5m
- 1 x Flexible 2 metre water supply hose
- 1 x flexible 2 metre drain hose
- 1 x PE ice scoop
- 1 x Single water filtration kit



Ice Discharge Options

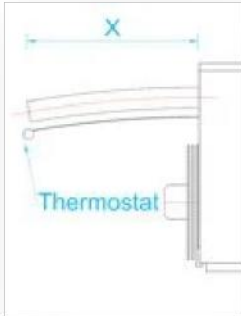

Ice Discharge type A

This is the standard no cost option for our small machines. OK in ambient environments that never drop below 5°C. A 60mm tube feeds ice from the back of the machine and senses the level of the ice by temperature probe.

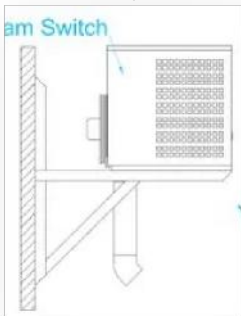

Ice Discharge type B

Especially suited when machine is located directly on top of an ice storage bin.

Ice discharges through bottom of machine via rigid 110mm Ø pipe. An ice jam switch in the top of the tube stops the machine when the bin is full.

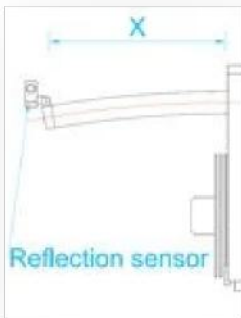

Ice Discharge type L

When a flexible hose is needed but the ice hose will be fed through a wall into a refrigerated atmosphere.

Ice discharges through the back of machine via a 60mm Ø flexible hose. A reflection sensor located at the end of the hose will stop the machine when the receptacle is full.



Ice Discharge Options

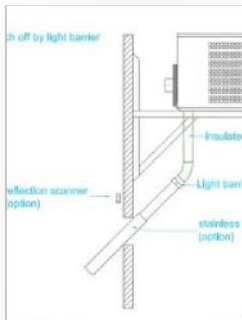

Ice Discharge type D

Ice discharges through the bottom of the machine via 54mm Ø flexible hose, 75mm Ø insulated. Level control via light barrier built into the hose.

A reflection sensor and / or 88.9mm Ø x 600mm stainless long end tube can be added as additional options. Designed for sauna applications when discharging through a wall into an adjacent room with ice receptacle.

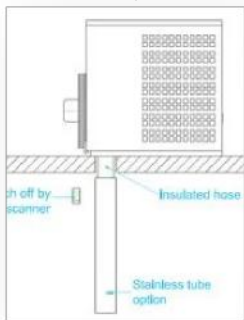

Ice Discharge type F

Ice discharges through the bottom of the machine via via 54mm Ø flexible hose, 75mm Ø insulated. Level control by externally mounted reflection sensor.

An 88.9mm Ø x 600mm stainless long end tube can be added as additional option. Designed for sauna applications when discharging through a ceiling into a room below with ice receptacle.

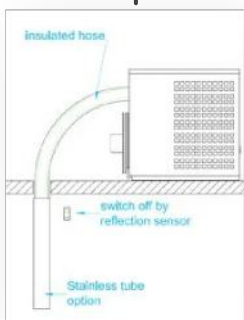

Ice Discharge type G

Ice discharges through the back of the machine via 54mm Ø flexible hose, 75mm Ø. Level control via externally mounted reflection sensor.

An 88.9mm Ø x 600mm stainless long end tube can be added as additional option. Designed for sauna applications when discharging through a ceiling into a room below when the machine cannot be placed directly above the ice receptacle.



Mounting Options



Wall Mounted Bracket

A pair of stainless mounting brackets to mount either the ice machine or a remote condenser on a wall. Allows the machine to be mounted at a convenient height for filling ice carts/bins below or discharge through a wall into another room depending on the ice discharge option chosen.



Stainless Support Frame

A frame to raise the ice machine to a more convenient working height, useful when the machine is to be floor standing. 90cm and 110cm with drain available. The machine can discharge into bins below or discharge through a wall, depending on the ice discharge option chosen.

The machine can be mounted on wall brackets, support frame or in on your own storage/cold-room, with a number of ice discharge options to suit your application.

Brackets and frames are not included as standard.



Configuration Options

Condenser Options

Water cooled instead of air-cooled: where air-cooling is not possible. Useful in applications where the machine must be installed into an area with poor ventilation where a remote aircooled condenser is not possible. Requires change to R452a

Water connections: 1/2" Male

Water flow: 160 l/h

Heat emission: 2.6kW

Remote condenser option: The condenser supplied separately to the machine for remote mounting, typically outside, when the machine is to be located in areas that are poorly ventilated or have airborne contamination such as flour dust. Available as standard for indoor mounting, weatherproof for outside mounting and cu/cu saltwater resistant for mounting in areas close to the sea. *Requires change to R452a*



Low noise condenser: Only for remote installation. Use when the condenser will be going in an area sensitive to noise, such as residential.

CoolNat Ice Maker only

For connection to a central CO2 refrigeration system

Frostguard

The machine equipped with a small heater to deal with intermittent temperatures below 5°C, only available in conjunction with remote condenser option above.

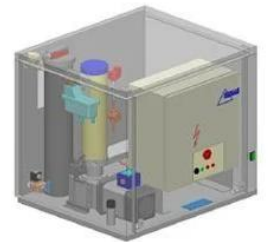

Frostguard, Insulation & Heating Cable

When machine is to be installed in a cold storage room. Available only in conjunction with remote condenser option above

Hygiene +: UV sterilization

Sterilization of the incoming water supply by mean of UV filter, all incoming water is passed through a powerful UV field on its way into the machine which kill almost all biohazards in the water supply. Slows down proliferation of water-borne bacteria inside the machine during operation.

Other options available on request



Contact Biddulph Refrigeration

Contact us today to learn more about how an ice machine can benefit your operation and to inquire about prices.

Invest in efficiency and quality!

service@biddulphrefrigeration.ie

